

### Features

- Pumps abrasive slurries, corrosive material, solids and gaseous liquids with ease
- Ideal for high viscosity or shear sensitive products
- Pumps can run-dry indefinitely without damage
- No check valves or seal water flush systems
- Fully reversible – pumps in either direction
- Minimal maintenance – the hose is the only wearing part
- Pump casings available in a choice of materials including stainless steel
- Suction lift capability up to 9.5 metres and self-priming
- Highly accurate

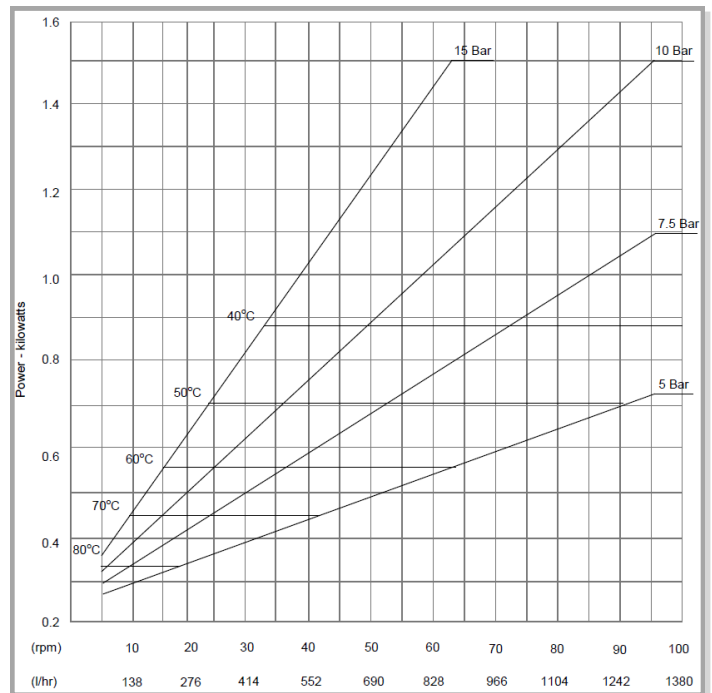
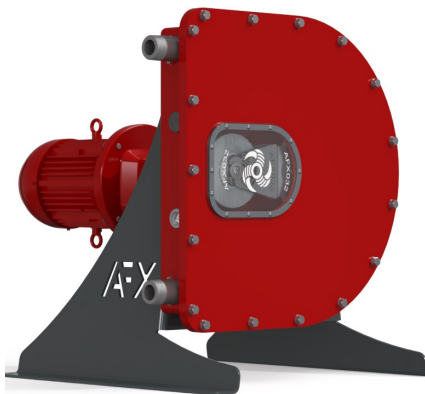

### Technical Specifications

Maximum intermittent flow rate of:	1,380 litres per hour
Maximum continuous flow rate of:	1,242 litres per hour
Flow per revolution of:	0.23 litres
Pressure capability of:	15 Bar
Maximum temperature:	80 Degrees Celsius
Inner hose diameter of:	20 mm

## Technical Specifications

Operating Speeds:	0 to 100rpm
Product Temperature Range:	-10 °C to +80 °C
Suction Lift:	9.5 metres lift
Hose Materials:	Natural Rubber, Nitrile (Buna), EPDM and CSM
Connections available:	DIN, ASA, JIS: mild steel galvanised
Hose Lubricant Required:	2.5 litres
Sound level at 1m:	< 70 dB(A) (pumping water at maximum continuous flow)
Optional Hose Failure Sensor:	Capacitive DC sensor

## Materials of Construction

Pump housing:	Carbon steel or stainless steel
Rotor:	Aluminium or carbon steel
Compression rollers:	Aluminium or Acetal
Front cover:	Carbon steel or stainless steel
Support Frame:	Carbon steel or stainless steel
Seals:	Neoprene or Nitrile

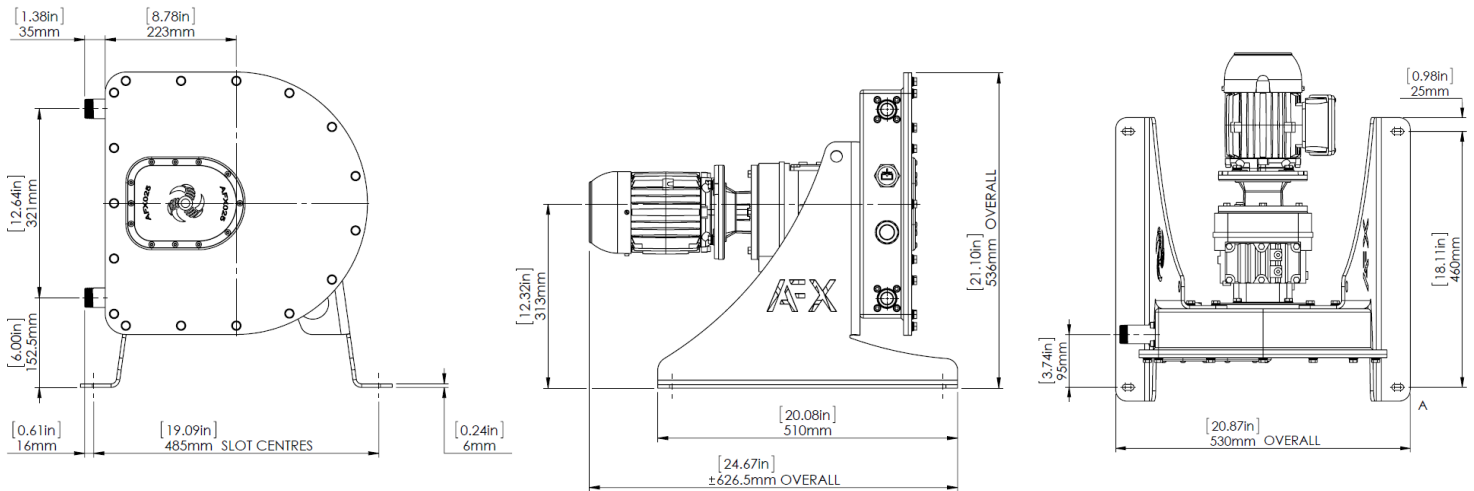

### Approximate Weight 74kgs

Actual weight depends upon drive fitted.  
Contact factory for details.

The information contained in this document is believed to be correct but neither AFX Holdings nor its subsidiary companies or distributors or representatives accept any liability for any errors or omissions and reserves the right to alter any specifications without notice. All values given in this document are values under controlled test conditions. Actual site flow rates achieved may differ due to changes in temperature, product viscosity, suction and discharge pressures and/or system configuration.